

www.qualitytested.com

Quality Tested[®]
Automotive Spare Parts

8.000 references

SUSPENSIONS FULL RANGE

FOR CARS AND COMMERCIAL VEHICLES

			
STANDARD SHOCK ABSORBERS STEERING DUMPER	COIL SPRINGS	COMPLETE ELECTRONICALLY CONTROLLED AIR SUSPENSIONS	AIR SUSPENSION COMPRESSORS SOLENOID VALVE BLOCKS
			
STRUT MOUNT	DUST COVER KIT	GAS SPRING	POWER LIFTGATE STRUTS

FULL PROGRAM OF SUSPENSIONS
FOR CARS AND COMMERCIAL VEHICLES
EUROPE | ASIA | USA



EQUIVALENTE ALL'ORIGINALE
EQUIVALENT TO THE ORIGINAL



24/48H ITALY/EUROPE
5 DAYS IN THE REST OF THE WORLD



GESTIONE GARANZIE VIA WEB
WEB WARRANTY MANAGEMENT



GARANZIA
WARRANTY



CATALOGO ON LINE
ONLINE CATALOGUE



THE MANUFACTURING PLANTS

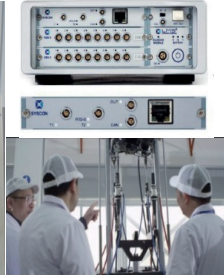

▶▶

**MTS849
PERFORMANCE
TEST STAND**

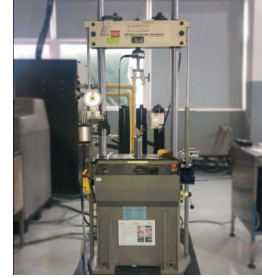

◀◀

**MTS850
PERFORMANCE
TEST STAND**

▶▶

**MTS
SEALING
TEST STAND**

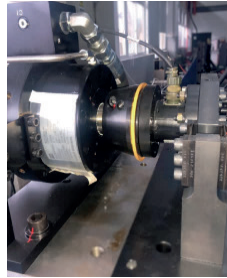
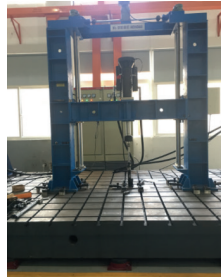

◀◀

**MTS TORSIONAL
VIBRATION
TEST STAND**

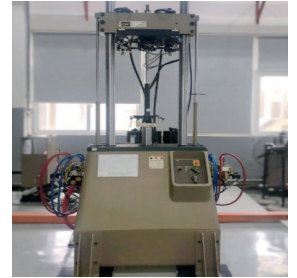

START

**STEEL PIPE
CUTTING**



▶▶

**MECHANICAL
PROCESSING**



◀◀

**FULL-AUTOMATIC
WELD LINE**

▶▶

**FINAL ASSEMBLY
(DUST-FREE
WORKSHOP)**



**ASSEMBLY LINE
(SPRING AND
STRUT MOUNT)**

▼



◀◀

**PAINTING
AND
PACKAGING**



THE EU DISTRIBUTION AUTOMATIC WAREHOUSE



SYSTEM CERTIFICATION

QUALITY ASSURED



The Company has been assessed and certified as meeting the requirements of **ISO 9001:2015**

This certificate is valid for the following scope of application:

**Commercialization
of Automotive Parts and Accessories
Certificate Number 612436**

QAICL Ref: IT/90039-A

TECHNICAL SPECS

GAS SHOCK

MAIN COMPONENTS

HYDRAULIC SHOCK

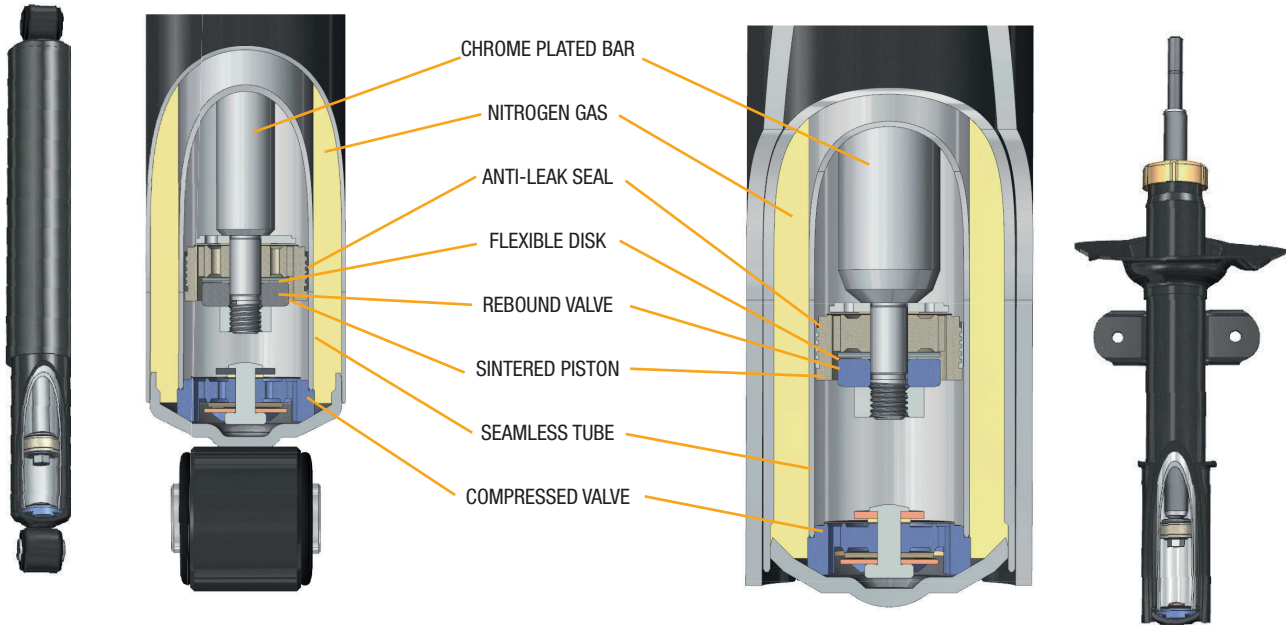

GAS SHOCK

- Stable Steer valves - better contact of the tires with the ground
- Sintered Iron piston - Higher durability and maximum performance
- Control Disk - Consistent control for comfort and stability
- Original Equipment Oil Seal - Less friction for maximum comfort and performance
- Super-finished Chrome Bar
- High Pressure Nitrogen Gas
- High precision cylinder - higher durability is guaranteed
- Selected excellent oil
- Low-friction DU bush - high durability

HYDRAULIC SHOCK

- Stable Valve Systems - Higher stability with control and performance
- Sintered Iron piston - Higher durability and maximum performance
- Control Disk - Consistent control for comfort and stability
- Original Equipment Oil Seal - Less friction for maximum comfort and performance
- Super-finished Chrome Bar
- High precision cylinder - higher durability is guaranteed
- Selected excellent oil
- Low-friction DU bush - high durability

MONO-TUBE SERIES

- Super High Pressure Nitrogen Gas
- Mono-tube construction - better cooling and prolong shock absorber life-span
- Multi-stage Control valve - Consistent control for comfort and stability
- Super-finished Chrome Bar
- Floating piston - Refined floor response
- High precision cylinder - higher durability is guaranteed



SOSPENSIONI • SUSPENSIONS • LENKUNG UND AUFHÄNGUNG • SUSPENSION • SUSPENSÃO • SUSPENSIÓN • СИСТЕМА ПОДРЕССОРИВАНИЯ • ZAWIESZENIE TWARDE

	<p>Ammortizzatori tradizionali • Standard Shock absorbers • Amortisseurs traditionnels • Stoßdämpfer • Amortecedores Tradicionais • Amortiguadores • Амортизатор • Amortyzator tradycyjny</p> <p>STEERING DAMPER</p>	<p>2.257 ITEMS</p> <hr/> <p>19 ITEMS</p>
	<p>Molle elicoidali • Coil springs • Ressorts hélicoïdaux • Schraubenfedern • Molas Helicoidais • Muelles Helicoidale • Винтовые пружины • Sprężyna śrubowa</p>	<p>3.020 ITEMS</p>
	<p>Sospensioni pneumatiche complete • Complete electronically controlled air suspensions • Suspension pneumatique complète à commande électronique • Voll elektronisch gesteuerte Luftfederung • Suspensões pneumáticas completas • Suspensión neumática completa controlada electrónicamente • Пневматическая подвеска с электронным управлением • Całkowicie sterowane elektronicznie zawieszenie pneumatyczne</p> <p>AIR SPRINGS</p>	<p>181 ITEMS</p> <hr/> <p>88 ITEMS</p>
	<p>Compressori per Sospensioni ad Aria • Air Suspension Compressors • Compresseurs de Suspension Pneumatique • Compressores de Suspensão a Ar ,Compresores de Suspensión Neumática • Компрессоры Пневматической Подвески • Luftfederkompressoren</p> <p>Blocchi elettrovalvola • Solenoid valve blocks • Blocs d'électrovannes • Magnetventilblöcke • Blocos de válvulas solenóides • Bloques de válvulas solenoide • блоки соленоидных клапанов • Bloki zaworowe</p>	<p>67 ITEMS</p> <hr/> <p>12 ITEMS</p>
	<p>Supporti ammortizzatori • Strut mount • Supports d'amortisseurs • Federbeinstützlager • Suporte de amortecedor • Soporte amortiguador • Опора стойки амортизатора • Łożysko amortyzatora</p>	<p>544 ITEMS</p>
	<p>Kit parapolvere, Ammortizzatore • Dust Cover Kit, shock absorber • Kit de protection contre la poussière, amortisseur • Staubschutzsatz, Stoßdämpfer • Kit de protecção contra o pó, amortecedor • Juego de guardapolvos, amortiguador • Пылезащитный Комплект, Амортизатор • Zestaw ochrony przeciwpy</p>	<p>345 ITEMS</p>
	<p>Ammortizzatori portellone e cofano • Gas spring • Amortisseurs de portail • Heckklappendämpfer / Gasfeder • Amortecedor de tampa de mala • Amortiguador porton trasero • Газовая пружина двери багажника • Sprężyna gazowa</p>	<p>1.304 ITEMS</p>
	<p>Ammortizzatori portellone elettrici • Power liftgate struts • Amortisseurs de porte électrique • Elektrische Heckklappendämpfer / Gasfeder • Amortecedor de tampa de mala eléctrico • Amortiguador portón trasero electrónico • Автопроводчик багажника • Amortyzator sterowany elektronicznie</p>	<p>74 ITEMS</p>

Per nuove applicazioni e novità si prega di accedere al sito www.qualitytested.com - For new applications and new items, please go to www.qualitytested.com

SUSPENSIONS FULL RANGE

FOR CARS AND COMMERCIAL VEHICLES



PRODUCT NEWS PRODUCT NEWS PRODUCT NEWS PRODUCT NEWS PRODUCT NEWS

PRODUCT NEWS

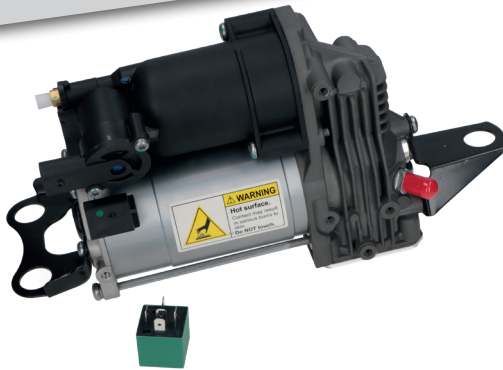

AIR SUSPENSION COMPRESSORS

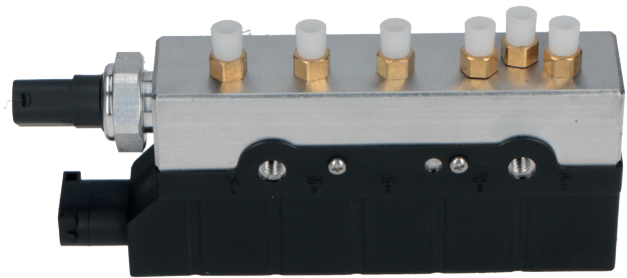

SOLENOID VALVE BLOCKS